

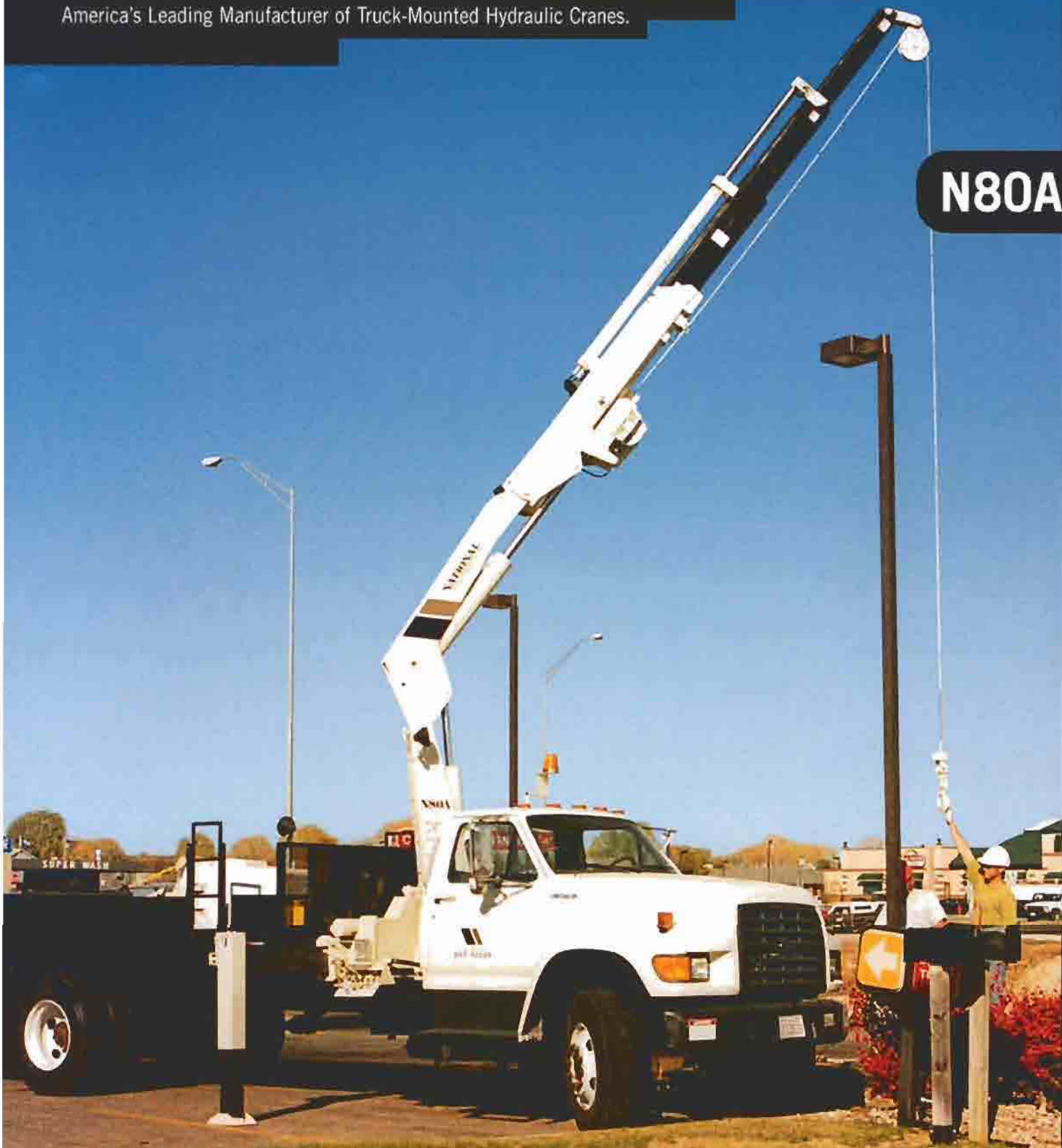

N80A: National Articulating Crane

America's Leading Manufacturer of Truck-Mounted Hydraulic Cranes.

N80A



National Pride

NATIONAL CRANE
A Grove Worldwide Company



Why Buy a National Series N80A?



Let's talk about your business. Are you willing to put your name on anything less than the best you have to give? Neither are we.

National Crane has been America's leading manufacturer of truck-mounted hydraulic cranes for three decades, even though there are less expensive cranes on the market. There's a reason for that, and the reason is people like you who won't settle for less than the best. National stands for quality, and quality means value - value that translates into profit for you. Look at what you get when you buy National:

- **Life Cycle Testing** - National cranes are tested with reference to American standards, ASME/ANSI-B30.22, AWS, SAE J1063 and OSHA regulations. National's own tests include cycle tests exceeding maximum crane capacity for cycles equivalent to the life of the crane! National is the only manufacturer of articulating cranes that designs, tests and builds products to all of these demanding levels. When you buy a National you can rest assured the crane you selected complies with all industry standards of the United States.
- **Made in America** - National Crane is the largest manufacturer of articulated cranes in North America. Because of our factory location, National Crane customers are accustomed to 24- to 48-hour parts shipments, not four to six weeks for parts shipped from foreign countries. With downtime costs reaching thousands of dollars a day, factory parts and service is an important consideration.
- **"Different" Boom Design and Hose Routings** - The N80A boom has a clean design with a single extend cylinder and cable crowd system. Our hydraulic hoses are routed internally where possible, to avoid snags or being severed should the boom contact an obstacle. Most competitive brands promote one cylinder attached to the side or top of each boom section, with numerous hoses and fittings just waiting to be damaged.
- **Hydraulic Outriggers** - The N80A includes hydraulic-out and hydraulic-down outriggers as a standard feature, not an add-on option. This feature provides for easy and efficient operation of the outriggers, unlike manual out/in outriggers that require the operator to manually extend and retract each one.
- **Load-holding Valves** - Our pilot-operated load-holding valves on the lift, fold and extend cylinders are located inside the cylinder butt plate for protection. This protects the holding valves from accidental damage that externally mounted valves are subject to, and eliminates the chance of valves being knocked off, causing the boom to free-fall.
- **SAE Fittings** - All hoses, fittings and hardware are SAE and available anywhere. While some foreign competitors claim to have SAE fittings, they still use metric cylinder packing and the fittings are actually metric-to-SAE conversions - a potential leak point.
- **Hydraulic Cylinders** - National Crane manufactures all lift, fold and extend cylinders. This assures our customers they will always be able to purchase these critical OEM parts locally, and not rely on a foreign source of supply.
- **Crane Controls** - All load charts are labeled in English, using standard weights and measurements. The control lever orientation and functions are identical on both sides of the machine - up is up on both sides. The controls are at waist level, with full illustration of the function at each control station. Control rods are different lengths to denote different operations.
- **Nationwide Distributor Network** - National's coast-to-coast distributor network means support is close at hand. You're not stuck dealing with a mass distributor who has little or no interest in your problem.

National Crane means more than a piece of equipment. National means dependability, minimum downtime, maximum safety and high resale value. When it comes right down to it, can you afford to buy a less expensive crane?



N80A Crane Specifications

Working pressure.....	5,450 psi.....	238 Bar
Pump capacity (gear pump).....	14 gal/min.....	53 l/min
Reservoir oil capacity (truck-mounted std.).....	30 gal.....	113.5 l
Outrigger span.....	14 ft.....	4.27 m
Outrigger vertical travel.....	25.4 in.....	645 mm
Stowed height (above truck frame).....	6 ft 11 in.....	2.11 m
Model N-80A/20 weight* with oil.....	4,280 lb.....	1,941 kg
Filter.....	10-micron replaceable (spin-on type).....	10 Hm
Rotation (non-continuous).....	390 degree	
Mounting space required.....	35.5 in.....	901 mm
With optional winch.....	41.5 in.....	1054 mm
With optional reel.....	43 in.....	1392 mm
Boom rotation speed.....	10 degrees per sec**	
Boom hydraulic extension/retraction speed		
Model 80A/20.....	0.65 ft/sec**.....	0.20 m/sec**
Model 80A/26.....	1.3 ft/sec**.....	0.40 m/sec**
Model 80A/32.....	0.8 ft/sec**.....	0.24 m/sec**

Note: Contact the factory for continuous duty cycle applications

*Crane options will increase crane weight

**Approximate



Crane Controls – All load charts are labeled in English. Control functions are identical on both sides of the machine – up is up on both sides. The controls are at waist level and illustrated by function at each control station. Control rods are different lengths to denote different operations.



Hydraulic Outriggers – The N80A includes hydraulic-out and hydraulic-down outriggers as a standard feature, not an add-on option. This feature provides for easy and efficient operation of the outriggers, unlike manual out/in outriggers that require the operator to manually extend and retract each one.



Crane shown with optional winch.

- Rotation: 390 degree (non-continuous)
- Maximum Load Moment: 92,700 ft•lb (12.82 t•m) at mounting surface
- Maximum Thrust Load: 19,170 lb (8696 kg) at mounting surface
- Maximum Rotational Moment: 17,570 ft•lb (2.43 t•m)



Minimum Mounting Specifications

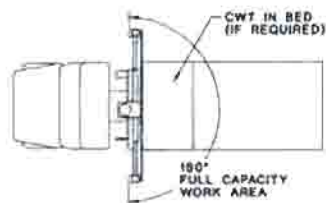
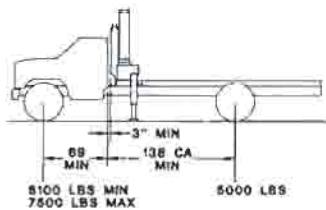

Behind Cab Mount/ 180-Degree Stability¹

- Minimum wheelbase: 207 in (5.26 m)
- Cab to rear axle (CA): 138 in (3.51 m)
- Recommended front axle rating: 10,860 lb (4926 kg) GAWRF
- Recommended rear axle rating: 19,000 lb (8618 kg) GAWRR
- Working area: 180 degrees
- Truck weight: 11,000 lb (4990 kg) minimum
- Chassis weight front axle: 6,100 lb (2767 kg) minimum⁴; 7,500 lb (3402 kg) maximum^{5**}
- Chassis weight rear axle: 5,000 lb (2268 kg) minimum⁴
- Frame 50,000 psi (344.75 MPa) steel: 15.9-in³ (260.55-cm³) section modulus
- Frame 110,000 psi (758.45 MPa) steel: 11-in³ (180.26-cm³) section modulus
- Frame height: 38 in (965 mm) or less preferred
- Power take-off: 33-hp (24.61 kW) minimum at 2,100 rpm output shaft speed

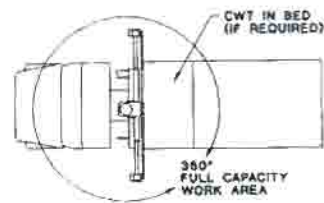
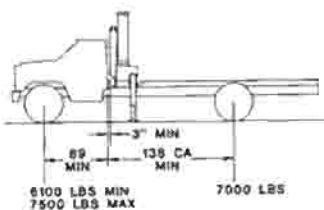

Behind Cab Mount/ 360-Degree Stability

- Minimum wheelbase: 207 in (5.26 m)
- Cab to rear axle (CA): 138 in (3.51 m)
- Recommended front axle rating: 10,860 lb (4926 kg) GAWRF
- Recommended rear axle rating: 19,000 lb (8618 kg) GAWRR
- Working area: 360 degrees
- Truck weight: 13,100 lb (5942 kg) minimum
- Chassis weight front axle: 6,100 lb (2767 kg) minimum⁴; 7,500 lb (3402 kg) maximum^{5**}
- Chassis weight rear axle: 7,000 lb (3175 kg) minimum⁴
- Frame 50,000 psi (344.75 MPa) steel: 15.9-in³ (260.55-cm³) section modulus
- Frame 110,000 psi (758.45 MPa) steel: 11-in³ (180-cm³) section modulus
- Frame height: 38 in (965 mm) or less preferred
- Power take-off: 33-hp (24.61 kW) minimum at 2,100 rpm output shaft speed

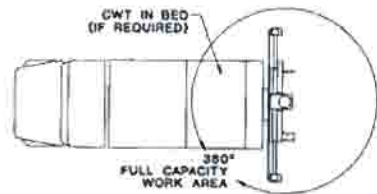
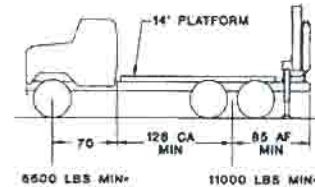

Rear Mount/ 360-Degree Stability

- Minimum wheelbase: 196 in (4.98 m)
- Cab to rear axle (CA): 126 in (3.20 m)
- After frame (AF): 85 in (2.16 m) minimum
- Recommended front axle rating: 12,000 lb (5443 kg) GAWRF
- Recommended rear axle rating: 34,000 lb (15,422 kg) GAWRR
- Working area: 360 degrees
- Truck weight: 16,500 lb (7484 kg) minimum
- Chassis weight front axle: 5,500 lb (2495 kg) minimum⁴
- Chassis weight rear axle: 11,000 lb (4990 kg) minimum⁴
- Frame 50,000 psi (344.75 MPa) steel: 21-in³ (344.13-cm³) section modulus
- Frame 110,000 psi (758.45 MPa) steel: 14-in³ (229.42-cm³) section modulus
- Frame height: 38 in (965 mm) or less preferred
- Power take-off: 33-hp (24.61 kW) minimum at 2,100 rpm output shaft speed

These notes pertain to the minimum mounting specifications shown above.

A truck used for mounting must meet the minimum requirements for capacity loads.

1. GAWR (Gross Axle Weight Rating) is dependent on all components of the vehicle (axles, tires, wheels, springs, brakes, steering and frame strength) meeting manufacturer's recommendations. Always specify GAWR when purchasing trucks.
2. Minimum axle requirements may increase with use of diesel engines, longer wheelbase or service bodies. Contact factory for further information.
3. Use caution when rotating boom from areas supported by outriggers to areas supported by springs—vehicle level changes as springs compress; rotate loads slowly and smoothly for maximum control.
4. Chassis weight may include bed, PTO, pump, rear bumper, or any other permanently attached items (other than the crane itself).
5. Diesel engines require variable speed governor.

¹Under-minimum front or rear axle chassis weights may require counterweight for stability

^{**}Maximum rating can be exceeded if GAWR is greater than 10,860 lb (4926 kg). Crane options will reduce the maximum allowable front axle



Reach and Capacity Data

N-80A Basic Features:

- 82,100-ft•lb (11.33-t•m) crane rating
- 7.2-ton (6.53-t) maximum capacity
- Hydraulic outriggers extend to 14 ft (4.27 m)
- 46-ft 11-in (14.30-m) maximum vertical reach*
- 38-ft 2-in (11.63-m) horizontal reach
- 30-ft 7-in (9.32-m) reach below truck frame
- 32-ft 1-in (9.78-m) total hydraulic extension
- Frame, inner boom, outer boom with one hydraulic extension to 20 ft 3 in (6.17 m)
- 390-degree positive rack-and-pinion rotation
- Five spool control valves
- Boom cylinder counterbalance valves with internal safety relief valve help protect against overload and hose failure; automatic check valves on outriggers
- Dual controls
- Manual truck throttle
- Clamp-on mounting
- Hydraulic reservoir and gear pump
- Crane hook

*All data is optimal and based on a specified truck frame height. Maximum vertical reach will vary depending on truck frame, tires, load, etc.

Caution:

Do not operate the crane (truck, boom/jib, accessories or loads) within 10 ft (3 m) of live power lines or any other source or conductor of electricity.

Note:

The N80A is a hook point machine. Capacities shown on the capacity charts are maximum loads at specific hook points, rather than at specific load radii or combination of boom angles and boom lengths.

A load can be lifted on a National articulating crane if the load is within the capacity of the hook point and its arc about the inner boom position. If the load is within the capacity of the hook point being used to lift the load, it can be positioned anywhere the hook arc permits by at least one crane function. All crane functions may not be able to move the load to all positions within the arc unless the position of the boom is at its best mechanical advantage. Capacities shown are based on optimal boom angles and configurations.

Model 80A/20

Mast, inner boom, and outer boom with one hydraulic extension to 20 ft 3 in (6.17 m)

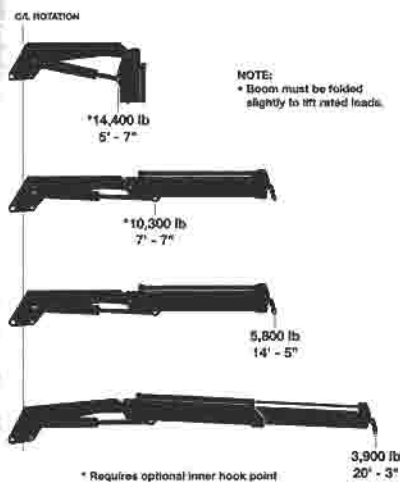

Model 80A/26

Mast, inner boom, and outer boom with two hydraulic extensions to 26 ft 1 in (7.95 m)

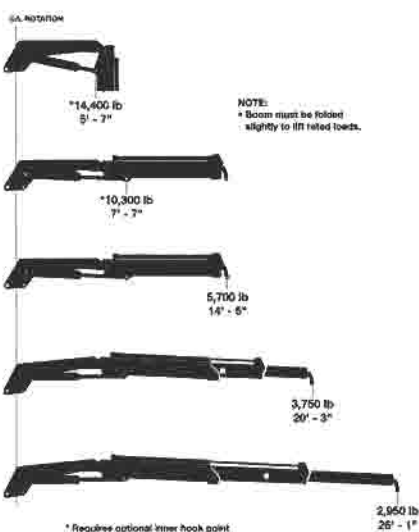

Model 80A/32

Mast, inner boom, and outer boom with three hydraulic extensions to 32 ft 1 in (9.78 m)

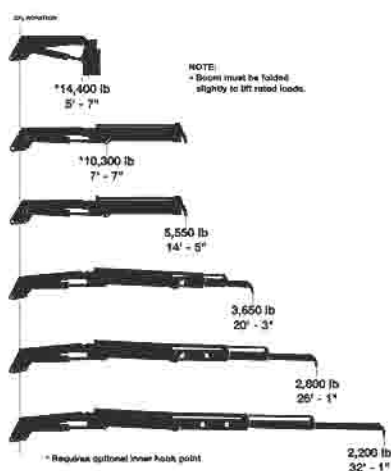

Model 80A/32/38

Mast, inner boom, and outer boom with three hydraulic extensions and one manual extension to 38 ft 2 in (11.63 m)

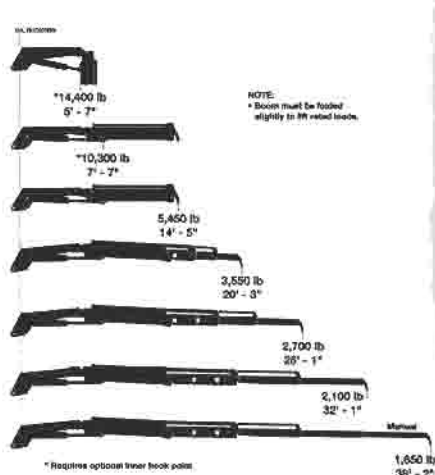

Model 80A/26/38 (not shown-available from factory)

Mast, inner boom, and outer boom with two hydraulic extensions and two manual extensions to 38 ft 2 in (11.63 m)



Accessories

Cabled Remote Controls — A one-hand remote control, ideal for precise control and total load visibility. Diesel engines require electric shut-off.

Radio Remote Controls — Eliminate the handling and maintenance concerns that accompany cabled remotes. Operate to a range of approximately 400 feet (122 m), varying with conditions.

Winch — Heavy-duty, easy single-pin attachment at boom-tip sheave head. Includes winch control and anti-two-block system.

Pallet Forks — A fork with 4,400-lb (1996-kg) capacity, plus adjustable throat and teeth.

Grapples — Grapples, available in butt or bypass type, with a hydraulic rotator and quick-connect fittings.

Clam Bucket — The clam bucket can be used to load or move materials in 1/3-yd³ (.25-m³) bites.

One-Person Basket — Gravity-hung steel with 300-lb (136-kg) capacity.

Hydraulic Auger — Provides digging depths up to 4 ft 6 in (1.4 m) and flightings up to 18 in (457 mm). Requires AH1.

Accessory Control Valves — Allow operation of hydraulic accessories, mount easily on the control panel.

Hydraulic Reels — Provides hydraulic accessory lines at the end of the hydraulic sections.

Dimensions Specifications:

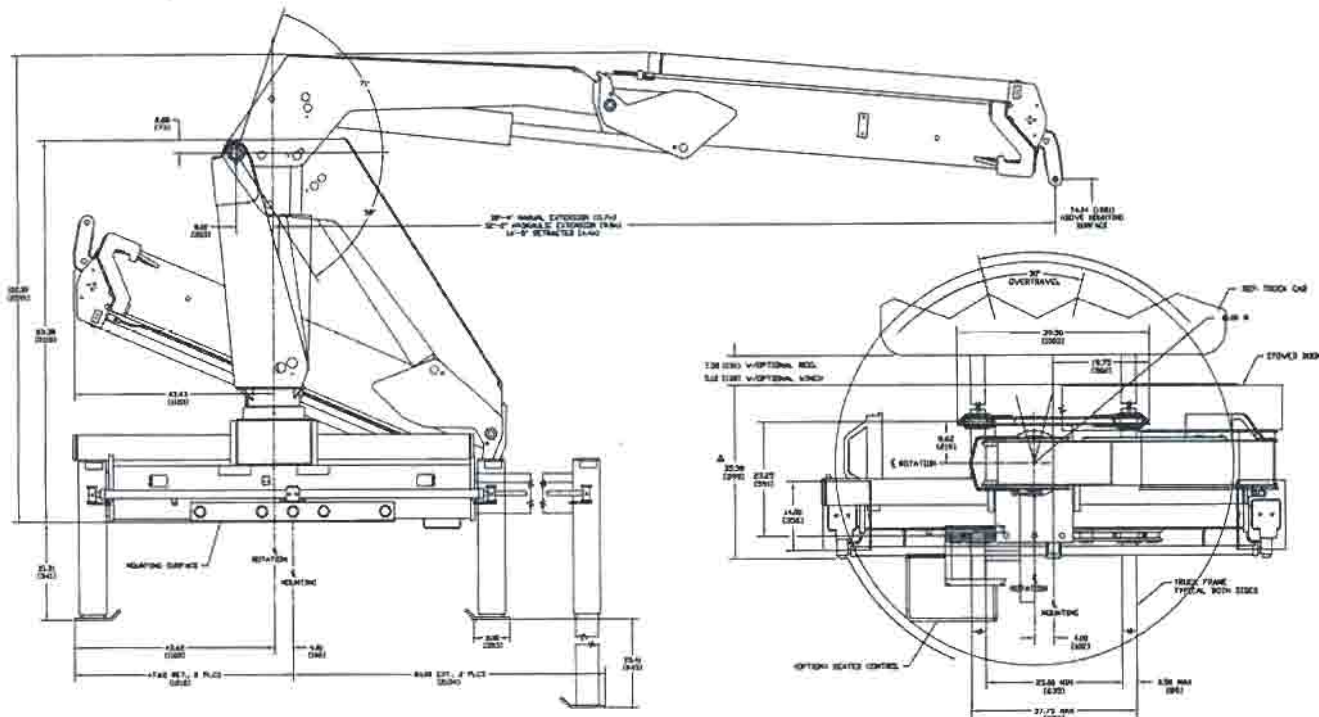

Dimensions are in inches (mm) unless otherwise specified.



NATIONAL CRANE
A Grove Worldwide Company

Your National Dealer:

National Crane is ISO 9001 Certified

General Offices:
11200 North 148th Street
Waverly, NE 68462 USA
Phone: (402) 786-6300
FAX: (402) 786-6363
Email: sales@nationalcrane.com
Web: www.nationalcrane.com

National Crane reserves the right to change designs, prices and specifications at any time without notice.
Printed in U.S.A. Form No. N80A/0900/5M/AA/JN