



View thousands of Crane Specifications on FreeCraneSpecs.com



View thousands of Crane Specifications on FreeCraneSpecs.com

Technical Data **Caractéristiques techniques**

LTM 1160/2

Mobile Crane **Grue automotrice**

Telescopic boom
Flèche télescopique

197 ft

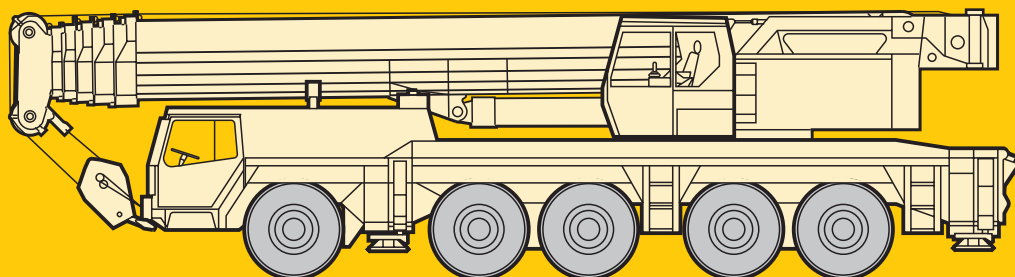

LIEBHERR



Lifting capacities on telescopic boom. Forces de levage à la flèche télescopique.

LTM 1160/2



43 ft – 197 ft



360°



110230 lbs

85%

ft	43 ft		57 ft	72 ft	86 ft	100 ft	114 ft	128 ft	142 ft	156 ft	171 ft	185 ft	197 ft	ft
	1)													
10	400*	317												10
11	327	303												11
12	293	288	271											12
13	275	274	254											13
14	261	261	241	226	203									14
15	249	248	230	215	195	169								15
16	240	238	223	208	189	165								16
17	232	228	216	201	182	161	133							17
18	224	218	210	195	176	157	132							18
20	209	200	197	183	164	149	129	111						20
22	193	185	183	173	154	140	123	108						22
24	178	171	170	164	144	132	118	104	88.5					24
26	163	158	157	154	136	124	112	100	86					26
28	151	147	146	144	128	117	107	96	83	71.5				28
30	140	136	136	134	121	111	102	92	80	69.5	58.9			30
32	127	126	127	125	115	105	97.5	88.5	77.5	67.5	57.6			32
34			119	117	109	99.5	92.5	85	74.5	66	56.2	46.9	36.1	34
36			112	110	104	95	88	81.5	72	64	54.8	46.1	35.6	36
38			105	102	99.5	90	83.5	78	69.5	62	53.4	45.4	35	38
40			98.5	96	94.5	86	79.5	75	67	60	52	44.5	34.5	40
45			84.5	82	81	77	71	68	61.5	56.1	48.7	42.2	32.6	45
50				71.5	70.5	69.5	64.5	61.5	57	52.4	45.7	39.7	30.8	50
55				62.5	61.5	61.5	59.2	56.1	52.8	48.9	43	37.4	29	55
60					53.6	53.9	54.2	51.4	48.9	45.6	40.5	35.1	27.3	60
65					47	47.3	48.1	47.5	45.3	42.7	38.3	33.2	25.7	65
70					41.7	41.9	42.9	43.4	42	39.9	36.3	31.4	24.3	70
75						37.1	38.3	39.3	38.8	37.2	34.3	29.8	22.9	75
80						33	34.1	35.5	35.5	34.7	32.5	28.3	21.7	80
85						29.5	30.5	31.9	32.2	32.4	30.7	26.9	20.6	85
90							27.5	28.8	29.3	30.2	28.8	25.7	19.4	90
95							24.7	26.8	26.6	27.9	26.9	24.6	18.4	95
100							20.7	25.4	24	25.5	25.2	23.5	17.3	100
105								23.9	21.8	23.2	23.5	22.6	16.4	105
110								22.6	19.8	21.2	21.7	21.7	15.5	110
115								20	18	19.3	20	20.6	14.7	115
120									17.2	17.6	18.3	19.4	13.9	120
125									16.7	16.1	17	17.8	13.2	125
130									16.4	14.7	16.1	16.4	12.4	130
135										14.2	15.4	15	11.7	135
140										13.8	14.8	13.8	11	140
145											14.2	12.7	10.3	145
150											13.2	11.6	9.7	150
155											12.3	10.6	9.1	155
160												9.7	8.6	160
165													8.1	165
170													7.6	170
175													7.2	175
I	0	0	46	92	92	92	92/0	92/0	92/0	92/46	92	100	100	I
II	0	46	46	46	92	92	92/92	92/46	92/92	92/92	92	100	100	II
III	0	0	0	0	0	46	46/92	92/92	92/92	92/92	92	100	100	III
IV	0	0	0	0	0	0	46/46	46/92	46/92	92/92	92	100	100	IV
V	0	0	0	0	0	0	0/46	0/92	46/92	46/92	92	100	100	V

1) over rear / en arrière

* with special equipment / avec équipement supplémentaire

TAB 103283 / 103284

Lifting capacities are given in kips (1,000 lbs). 2



Lifting capacities on telescopic boom. Forces de levage à la flèche télescopique.

LTM 1160/2



43 ft - 197 ft



360°



77160 lbs

85%

ft	43 ft	57 ft	72 ft	86 ft	100 ft	114 ft	128 ft	142 ft	156 ft	171 ft	185 ft	197 ft	ft
10	317												10
11	300												11
12	285	271											12
13	270	254											13
14	257	241	226	203									14
15	244	230	215	195	169								15
16	233	223	208	189	165								16
17	222	215	201	182	161	133							17
18	213	208	195	176	157	132							18
20	194	193	183	164	149	129	111						20
22	178	177	172	154	140	123	108						22
24	163	162	160	144	132	118	104	88.5					24
26	150	149	147	136	124	112	100	86					26
28	139	138	135	128	117	107	96	83	71.5				28
30	128	127	124	119	110	102	92	80	69.5	58.9			30
32	119	117	115	109	103	97.5	88.5	77.5	67.5	57.6			32
34		109	106	100	96	92	85	74.5	66	56.2	46.9	36.1	34
36		102	98	92.5	89	86	81.5	72	64	54.8	46.1	35.6	36
38		94.5	90.5	85	82.5	80.5	78	69.5	62	53.4	45.4	35	38
40		88	83	78.5	76	75	74.5	67	60	52	44.5	34.5	40
45		77.5	70	66	64	63.5	63.5	61.5	56.1	48.7	42.2	32.6	45
50			59.9	56.3	54.8	54.6	54.7	54.1	52.4	45.7	39.7	30.8	50
55			51.2	48.4	47.2	47.2	47.6	47.2	47.7	43	37.4	29	55
60				41.9	40.8	41	41.8	41.4	42.2	40.4	35.1	27.3	60
65				36.4	35.8	36	38.8	36.6	37.5	37.3	33.2	25.7	65
70				31.4	33.3	31.7	36.2	33.7	33.5	33.5	31.4	24.3	70
75					31.1	27.9	33.5	31.3	30	30.1	29.7	22.9	75
80					29.2	25.3	30.6	29	26.8	28.3	27.8	21.7	80
85					27.5	23.7	27.7	26.9	25.2	26.8	25.2	20.6	85
90						22.3	25.3	24.9	23.7	24.8	22.9	19.4	90
95						21.1	22.9	23.1	22.3	22.8	20.9	18.4	95
100						20	20.7	21.4	20.8	20.9	19	17.3	100
105							18.6	19.4	19.4	19.2	17.3	16.4	105
110							16.9	17.7	18.3	17.5	15.8	15.3	110
115							15.3	16.4	16.9	16	14.3	14	115
120								15.8	15.5	14.6	12.9	12.7	120
125								15.3	14.1	13.2	11.6	11.3	125
130								14.2	13	12.1	10.4	10.2	130
135									12	11	9.3	9.1	135
140									11	10	8.3	8.1	140
145										9.1	7.4	7.2	145
150										8.3	6.6	6.5	150
155										7.6	6	5.8	155
160											5.3	5.2	160
165												4.6	165
170												4	170
175												3.4	175
I	0	0/ 0	46	92	92/ 0	92/ 0	92/ 0	92/ 0/ 0	92/ 0	92/46	92	100	I
II	0	46/ 0	46	46	92/ 0	92/ 0	92/92	92/92/46	92/92	92/92	92	100	II
III	0	0/ 0	0	0	0/92	46/92	46/92	92/92/92	92/92	92/92	92	100	III
IV	0	0/ 0	0	0	0/46	0/92	46/46	46/92/92	46/92	92/92	92	100	IV
V	0	0/46	0	0	0/46	0/46	0/46	0/46/92	46/92	46/92	92	100	V

TAB 103285

Les forces de levage sont données en kips (1,000 lbs).





Lifting capacities on telescopic boom. Forces de levage à la flèche télescopique.

LTM 1160/2



43 ft - 197 ft



360°

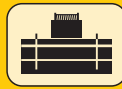

50706 lbs

85%

ft	43 ft	57 ft	72 ft	86 ft	100 ft	114 ft	128 ft	142 ft	156 ft	171 ft	185 ft	197 ft	ft
10	285												10
11	269												11
12	255	246											12
13	241	231											13
14	229	219	206	184									14
15	218	209	195	178	153								15
16	207	202	189	171	150								16
17	197	194	183	166	146	121							17
18	188	186	177	160	142	120							18
20	169	169	166	149	135	117	101						20
22	154	153	151	138	128	112	97.5						22
24	140	139	136	126	118	107	94.5	80.5					24
26	127	126	121	112	105	101	90.5	78					26
28	116	115	109	101	95.5	92	86.5	75.5	65				28
30	106	105	97.5	91	86.5	84	82	73	63	53.6			30
32	97	96	89	83	79	77	75.5	70	61.5	52.3			32
34		88	81.5	76	72.5	71	70	66.5	59.8	51.1	42.6	32.8	34
36		80	75	70	67	66	65	62.5	58.1	49.8	41.9	32.3	36
38		74	68.5	64.5	61.5	60.5	60	58.2	56.4	48.5	41.2	31.9	38
40		69.5	63	59	56.7	55.9	55.5	54.2	54.2	47.3	40.5	31.3	40
45		57.2	52.2	48.5	46.8	46.5	49.5	44.7	46.2	44.3	38.4	29.7	45
50			47.2	40.4	41.7	39.2	44.3	41.5	39.7	39.2	36.1	28	50
55			41.6	35.1	38.2	33.5	39.2	38.1	34.3	34.2	33.5	26.3	55
60				32.5	35	30.8	34.2	34.3	31.4	32	30.3	24.8	60
65				30.3	31.5	28.4	30.2	30.3	29.4	29.1	26.8	23.4	65
70				28.4	27.8	26.4	26.8	27	27.1	26.1	23.8	22.1	70
75					24.5	24.5	23.7	24.7	24.6	23.3	21.1	20.4	75
80					21.7	22.6	20.8	22.9	22.1	20.9	18.8	18.4	80
85					19.3	20.1	18.9	21	19.9	18.8	16.7	16.4	85
90						18.7	17.5	19	18	16.9	14.9	14.6	90
95						17.6	16.4	17.1	16.2	15.2	13.3	13	95
100						16.3	15.2	15.4	14.4	13.7	11.8	11.5	100
105							14.1	13.8	12.9	12.1	10.4	10.2	105
110							12.8	12.5	11.5	10.7	9	8.8	110
115							11.6	11.3	10.3	9.5	7.8	7.6	115
120								10.2	9.2	8.4	6.8	6.6	120
125								9.2	8.2	7.3	5.9	5.7	125
130								8.3	7.3	6.5	5.1	4.9	130
135									6.4	5.8	4.4	4.2	135
140									5.7	5.1	3.7	3.5	140
145										4.4	3.1		145
150										3.7	2.4		150
155										3.1			155
I	0	0/0	46/0	92/0	92/0	92/0/0	92/0/0	92/0/0	92/0	92/46	92	100	I
II	0	46/0	46/0	46/0	92/0	92/0/0	92/92/0	92/92/46	92/92	92/92	92	100	II
III	0	0/0	0/0	0/0	0/92	46/92/46	46/92/92	92/92/92	92/92	92/92	92	100	III
IV	0	0/0	0/46	0/46	0/46	0/92/92	46/46/92	46/92/92	46/92	92/92	92	100	IV
% V	0	0/46	0/46	0/92	0/46	0/46/92	0/46/92	0/46/92	46/92	46/92	92	100	V

TAB 103267



Lifting capacities on telescopic boom. Forces de levage à la flèche télescopique.

LTM 1160/2



43 ft - 197 ft



360°



24250 lbs

85%

ft	43 ft	57 ft	72 ft	86 ft	100 ft	114 ft	128 ft	142 ft	156 ft	171 ft	185 ft	197 ft	ft
10	281												10
11	265												11
12	250	246											12
13	237	231											13
14	224	219	206	184									14
15	211	208	195	178	153								15
16	200	198	189	171	150								16
17	189	188	178	161	143	120							17
18	179	178	165	149	134	117							18
20	160	158	139	126	116	110	100						20
22	143	136	120	110	102	97.5	92						22
24	127	118	105	96	90	86	83	78					24
26	113	104	92	84.5	79	76	74	70.5					26
28	99	93.5	82	75	70.5	68.5	70.5	64	62				28
30	85.5	88.5	72.5	66.5	63.5	61	66.5	58	57.4	53.2			30
32	75.5	80	67.5	59.5	60.5	55.3	61	55.8	52.6	50.4			32
34		72.5	64.5	53.9	57.8	50.9	56.3	53	48.5	47.3	42.2	32.8	34
36		65.5	61	49.9	55.3	48.7	52.1	49.9	45	43.9	40.8	32.3	36
38		58.7	57.7	47.8	52.7	46.5	48	46.7	43.4	42.4	39.4	31.9	38
40		52.7	54.1	45.8	50	44.5	44.3	43.7	41.7	41	37.7	31.3	40
45		42.2	43.4	41.6	41.8	40.2	37.1	38.6	36.6	34.8	31.9	29.7	45
50			35.7	37.3	35.6	35.2	33.8	33.9	31.6	29.9	27.2	26.2	50
55			30.7	32.7	30.3	30.4	30.5	29.5	27.3	25.8	23.3	22.6	55
60				27.8	25.9	27.6	26.9	25.7	23.7	22.3	20	19.4	60
65				24	22.1	24.7	23.7	22.5	20.7	19.4	17.2	16.7	65
70				21	20.5	21.8	21	19.9	18.1	17	14.8	14.4	70
75					18.5	19.1	18.5	17.6	15.9	14.8	12.8	12.4	75
80					16.3	16.8	16.3	15.6	13.9	12.9	10.9	10.6	80
85					14.3	14.8	14.2	13.8	12.2	11.2	9.3	9	85
90						13.1	12.5	12.1	10.7	9.7	7.8	7.6	90
95						11.6	11	10.6	9.2	8.3	6.5	6.3	95
100						10.2	9.6	9.3	7.9	7	5.4	5.2	100
105							8.4	8	6.7	5.9	4.4		105
110							7.4	7	5.8	5	3.5		110
115							6.4	6.1	5	4.2			115
120								5.3	4.2	3.4			120
125								4.5	3.5				125
130								3.8	2.8				130
I	0	0/ 0	46/ 0/ 0	92/ 0	92/ 0/ 0	92/ 0/ 0	92/ 0/ 0	92/ 0/ 0	92/ 0	92/46	92	100	I
II	0	46/ 0	46/ 0/ 0	46/ 0	92/ 0/ 0	92/ 0/ 0	92/92/ 0	92/92/46	92/92	92/92	92	100	II
III	0	0/ 0	0/ 0/ 0	0/ 0	0/92/ 0	46/92/46	46/92/92	92/92/92	92/92	92/92	92	100	III
IV	0	0/ 0	0/46/ 0	0/46	0/46/92	0/92/92	46/46/92	46/92/92	46/92	92/92	92	100	IV
% V	0	0/46	0/46/92	0/92	0/46/92	0/46/92	0/46/92	0/46/92	46/92	46/92	92	100	V

TAB 103268



Lifting capacities on telescopic boom. Forces de levage à la flèche télescopique.

LTM 1160/2



43 ft – 197 ft



360°

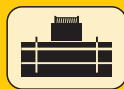

0 lbs

85%

ft	43 ft	57 ft	72 ft	86 ft	100 ft	114 ft	128 ft	142 ft	156 ft	171 ft	185 ft	197 ft	ft
10	276												10
11	260												11
12	245	244											12
13	229	228											13
14	216	213	188	162									14
15	203	197	165	144	129								15
16	190	175	148	130	118								16
17	177	158	134	119	108	99.5							17
18	162	144	123	108	98.5	91.5							18
20	134	117	101	89	84	76.5	81						20
22	114	103	87.5	75.5	79	69	71						22
24	96	92.5	81	67	73	65.5	62.5	60					24
26	81.5	79.5	74	63	65	62	55.6	54.5					26
28	70	70	66	60	58.5	56.3	52.2	50.8	47.5				28
30	60	61.5	58.4	56.7	52.3	50.7	49.5	46.8	43.1	40.2			30
32	51.9	55.1	52.5	52.8	47.3	47.2	45.5	42.9	39.5	36.8			32
34		49.5	49	48.8	43.2	44.4	42	39.5	36.3	33.9	30.4	29.2	34
36		44.7	44.9	44.9	39.6	41.2	38.8	36.6	33.6	31.3	28.1	27	36
38		39.8	40.9	41	36.1	38.1	35.7	33.6	30.9	28.8	25.7	24.7	38
40		35.4	37.2	37.5	32.9	35.2	32.8	31	28.4	26.4	23.5	22.6	40
45		27.6	29.9	31	26.8	29.3	27.3	25.8	23.5	21.8	19.2	18.5	45
50			24.2	25.9	22.1	24.8	23	21.7	19.6	18.2	15.7	15.2	50
55			19.6	21.6	18.3	21	19.4	18.3	16.4	15.1	12.8	12.3	55
60				18	15.2	17.9	16.5	15.5	13.7	12.5	10.3	9.9	60
65				15	12.6	15.4	14	13.1	11.4	10.3	8.3	7.9	65
70				12.6	10.4	13.3	12	11.1	9.5	8.5	6.5	6.3	70
75					8.4	11.3	10.2	9.4	7.9	6.9			75
80					6.7	9.6	8.5	7.9	6.4	5.5			80
85					5.2	8	7	6.5	5.1	4.2			85
90						6.8	5.9	5.4					90
95						5.6	4.9	4.4					95
100						4.6	4						100
I	0	0/ 0	46/ 0/ 0	92/ 0	92/ 0/ 0	92/ 0/ 0	0/ 0	0/ 0	0	46	92	100	I
II	0	46/ 0	46/ 0/ 0	46/ 0	92/ 0/ 0	92/ 0/ 0	92/ 0	92/46	92	92	92	100	II
III	0	0/ 0	0/ 0/ 0	0/ 0	0/92/ 0	46/92/46	92/92	92/92	92	92	92	100	III
IV	0	0/ 0	0/46/ 0	0/46	0/46/92	0/92/92	46/92	92/92	92	92	92	100	IV
% V	0	0/46	0/46/92	0/92	0/46/92	0/46/92	46/92	46/92	92	92	92	100	V

TAB 103269

Remarks referring to load charts.

- The tabulated lifting capacities do not exceed 85% of the tipping load.
- The crane's structural steelwork is in accordance with DIN 15018, part 3. Design and construction of the crane comply with DIN 15018, part 2, and with F.E.M. regulations.
- The 85% overturning limit values take into account wind force 5 = wind speed 20 mph.
- Lifting capacities are given in kips.
- The weight of the hook blocks and hooks must be deducted from the lifting capacities.
- Working radii are measured from the slewing centreline.
- The lifting capacities given for the telescopic boom only apply if the folding jib is taken off.
- Lifting capacities are subject to modifications.
- Lifting capacities above 317 kips only with special equipment.

Remarques relatives aux tableaux des charges.

- Les forces de levage indiquées ne dépassent pas 85% de la charge de basculement.
- La norme DIN 15018, 3ème partie est appliquée pour les charpentes. La construction de la grue est réalisée conformément à la norme DIN 15018, 2ème partie, et aux règles de la F. E. M.
- A 85% de la charge de basculement, il a été tenu compte d'un vent de force 5 = vitesse de vent 20 mph.
- Les forces de levage sont données en kips.
- Le poids des moufles et crochets doit être soustrait des charges indiquées.
- Les portées sont calculées à partir de l'axe de rotation.
- Les forces indiquées pour la flèche télescopique s'entendent fléchette dépliée déposée.
- Les forces de levage sont modifiables sans préavis.
- Forces de levage plus de 317 kips seulement avec équipement supplémentaire.



Lifting heights. Hauteurs de levage.

LTM 1160/2

Telescopic boom.
Flèche télescopique.

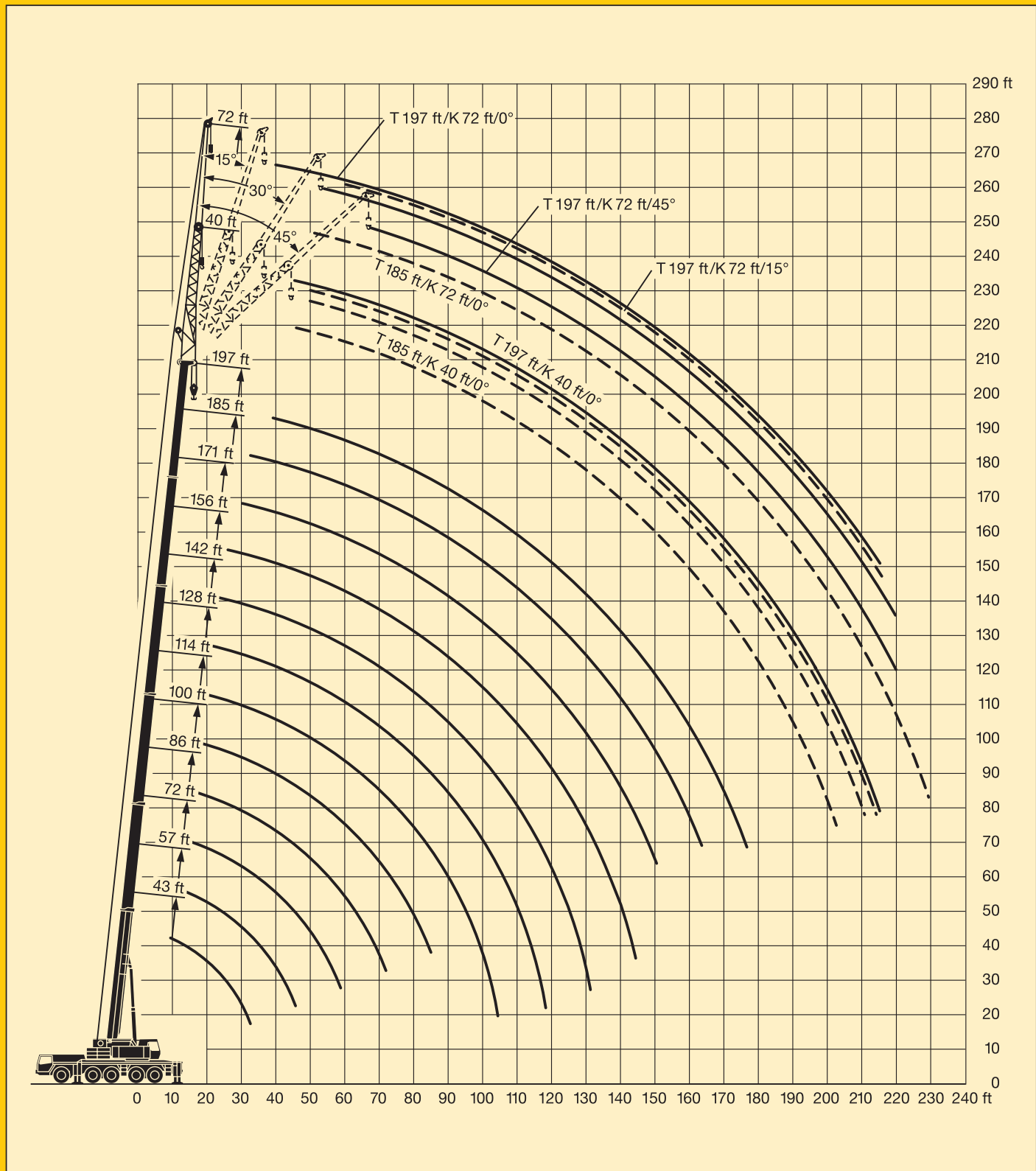



Lifting capacities on the folding jib. Forces de levage à la fléchette pliante.

LTM 1160/2



142 ft – 197 ft

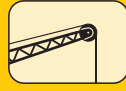

0°/15°/30°/45°
40 ft



360°



110230 lbs

85%

ft	142 ft				156 ft				171 ft				185 ft				197 ft				ft	
	40 ft				40 ft				40 ft				40 ft				40 ft					
	0°	15°	30°	45°	0°	15°	30°	45°	0°	15°	30°	45°	0°	15°	30°	45°	0°	15°	30°	45°		
28	42.4				38.1																28	
30	42.4				38				32.5													30
32	42.4				37.7				32.5													32
34	42.2	33.6			37.5				32.4				25.4									34
36	41.9	32.9			37.3				32.3				25.2									36
38	41.5	32.3			37.1				32.1				25.1									38
40	41.1	31.6			36.9	30.2			31.9	26.7			24.9				18.9					40
45	40.2	29.9			36.1	29.1			31.1	26.7			24.4				18.5					45
50	39.1	28.4	21.2		35.3	27.8	20.7		30	26.2	20.4		23.7	22.6			18	16.7				50
55	37.5	27	20.5	16.7	34.3	26.5	20.1	16.6	28.8	25.5	19.9	16.2	22.9	21.9	19.3		17.4	16.3	15.4			55
60	35.4	25.7	19.8	16.3	33.1	25.4	19.6	16.2	27.5	24.6	19.4	16	22	21	18.8	15.5	16.8	15.8	14.7	13.3		60
65	33.4	24.6	19.2	16	31.3	24.3	19	15.9	26.2	23.8	18.8	15.8	21	20	18.3	15.3	16	15	14	12.9		65
70	31.7	23.6	18.7	15.7	29.6	23.4	18.6	15.7	25	23	18.4	15.6	20.1	19.1	17.9	15.1	15.2	14.2	13.4	12.5		70
75	30	22.7	18.2	15.5	28	22.6	18.1	15.5	23.8	22	17.9	15.4	19.2	18.2	17.4	14.9	14.4	13.5	12.8	12.1		75
80	28.5	21.8	17.7	15.3	26.5	21.8	17.7	15.3	22.6	21	17.5	15.2	18.3	17.4	16.7	14.8	13.6	12.8	12.2	11.6		80
85	27	21.1	17.3	15.1	25.1	21.1	17.3	15.1	21.5	20	17.2	15	17.5	16.6	16	14.6	12.9	12.1	11.6	11.2		85
90	25.6	20.4	16.9	14.9	23.9	20.4	16.9	14.9	20.4	19.1	16.8	14.9	16.6	15.8	15.3	14.4	12.2	11.5	11	10.7		90
95	24.4	19.7	16.5	14.8	22.7	19.8	16.6	14.7	19.4	18.3	16.5	14.7	15.9	15.1	14.7	14.1	11.5	10.9	10.4	10.2		95
100	23.2	19.1	16.2	14.6	21.6	19.2	16.3	14.6	18.5	17.5	16.2	14.6	15.1	14.4	14	13.8	10.9	10.3	9.9	9.7		100
105	22.1	18.5	15.9	14.5	20.6	18.7	16	14.5	17.6	16.8	15.8	14.4	14.5	13.8	13.4	13.3	10.4	9.8	9.5	9.3		105
110	20.5	18	15.6	14.4	19.6	18.2	15.7	14.4	16.8	16.1	15.5	14.3	13.8	13.2	12.9	12.8	9.8	9.4	9	8.9		110
115	18.8	17.6	15.4	14.4	18.6	17.8	15.5	14.3	16	15.5	15	14.1	13.2	12.7	12.4	12.3	9.3	8.9	8.6	8.5		115
120	17.1	17	15.2	14.3	17.5	17.3	15.3	14.3	15.3	14.8	14.4	14	12.6	12.1	11.9	11.8	8.9	8.5	8.3	8.1		120
125	15.5	16.4	15	14.3	16.1	16.8	15.1	14.3	14.6	14.3	13.9	13.8	12.1	11.6	11.4	11.4	8.5	8.1	7.9	7.8		125
130	14.1	14.9	14.8	14.3	14.7	15.5	15	14.3	14	13.7	13.5	13.4	11.6	11.2	11	11	8.1	7.8	7.6	7.5		130
135	12.8	13.5	14	13.9	13.4	14.2	14.4	14.2	13.3	13.1	13	13	11.1	10.7	10.6	10.6	7.7	7.5	7.3	7.3		135
140	11.5	12.2	12.8	13	12.1	12.9	13.5	13.6	12.3	12.5	12.5	12.6	10.7	10.3	10.2	10.3	7.3	7.2	7.1	7		140
145	10.4	11	11.5	11.7	11	11.7	12.2	12.5	11.1	11.9	12	12.1	10.3	10	9.9	9.9	6.9	6.9	6.8	6.8		145
150	9.3	9.9	10.3	10.4	9.9	10.6	11	11.3	10	10.7	11.2	11.5	9.9	9.6	9.5	9.6	6.5	6.6	6.6	6.6		150
155	8.3	8.8	9.1	9.2	8.9	9.5	9.9	10.1	9.3	9.7	10.2	10.5	9.3	9.3	9.2	9.3	6.1	6.3	6.4	6.4		155
160	7.6	7.9	8.1		8.2	8.5	8.8	9	9	8.7	9.1	9.4	8.5	8.8	8.9	9	5.7	6	6.1	6.2		160
165	7.2				7.9	7.9	7.9	8	8.6	8.3	8.3	8.5	7.7	8.2	8.6	8.7	5.3	5.7	5.8	6		165
170	6.9				7.6	7.5	7.6	7.6	8.3	8.1	8.1	8.3	7.1	7.5	7.8	7.9	4.9	5.4	5.5	5.6		170
175					7.2	7.2			7.8	7.8	7.8	8	6.5	6.9	7.1	7.3	4.6	5	5.2	5.4		175
180									7.3	7.5	7.5	7.6	6	6.3	6.5	6.7	4.2	4.7	4.9	5		180
185									6.8	7	7.2		5.5	5.8	6	6.1	3.9	4.4	4.6	4.7		185
190									6.4	6.5	6.6		5	5.3	5.4	5.5	3.7	4.1	4.3	4.4		190
195													4.5	4.8	4.9	5	3.4	3.8	4	4		195
200													4.1	4.4	4.5	4.4	3.2	3.5	3.7	3.7		200
205																	3	3.3	3.4	3.5		205
210																	2.8	3	3.3			210
215																	2.7	2.8	2.9			215
I		92				92				92/46				92				100			I	
II		92				92				92/92				92				100			II	
III		92				92				92/92				92				100			III	
IV		46				46				92/92				92				100			IV	
% V		0				46				46/92				92				100			V	

TAB 103326 / 103328 / 103330 / 103332



Lifting capacities on the folding jib. Forces de levage à la fléchette pliante.

LTM 1160/2

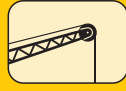

142 ft - 197 ft

0°/15°/30°/45°
72 ft*

360°



110230 lbs

85%

ft	142 ft				156 ft				171 ft				185 ft				197 ft				ft	
	72 ft				72 ft				72 ft				72 ft				72 ft					
	0°	15°	30°	45°	0°	15°	30°	45°	0°	15°	30°	45°	0°	15°	30°	45°	0°	15°	30°	45°		
30	18.2																					30
32	18.2																					32
34	18.2				17																	34
36	18.2				17																	36
38	18.2				17																	38
40	18.2				17				15.7				13.8				11.4					40
45	18				16.8				15.6				13.8				11.2					45
50	17.6	14.6			16.6				15.3				13.7				10.9					50
55	17.3	14.4			16.3	13.9			15.1	13.2			13.6				10.6					55
60	16.9	14.1			16	13.5			14.9	12.9			13.5	12			10.3	9.6				60
65	16.3	13.6			15.6	13.1			14.6	12.5			13.3	11.7			10	9.3				65
70	15.8	13.2	11		15.1	12.8	10.7		14.3	12.2			13.1	11.4			9.7	8.9				70
75	15.3	12.8	10.7		14.7	12.4	10.4		13.9	11.9	10.1		12.9	11.2	9.6		9.4	8.6	7.5			75
80	14.8	12.4	10.4	8.7	14.3	12	10.2	8.7	13.6	11.6	9.9	8.7	12.6	10.9	9.4		9.1	8.2	7.3			80
85	14.3	12	10.2	8.7	13.9	11.7	10	8.7	13.2	11.3	9.7	8.5	12.2	10.7	9.3		8.7	7.9	7			85
90	13.8	11.6	9.9	8.6	13.4	11.4	9.8	8.6	12.9	11	9.5	8.5	11.8	10.5	9.1	8.2	8.4	7.6	6.8	6.3		90
95	13.4	11.3	9.7	8.5	13.1	11.1	9.6	8.5	12.6	10.8	9.4	8.4	11.3	10.3	9	8.2	8	7.3	6.6	6.2		95
100	13	11	9.5	8.5	12.7	10.8	9.4	8.4	12.2	10.5	9.2	8.3	10.9	10	8.9	8.1	7.6	7	6.3	6		100
105	12.5	10.7	9.3	8.3	12.3	10.5	9.2	8.3	11.9	10.3	9	8.2	10.5	9.7	8.8	8	7.2	6.8	6.1	5.8		105
110	12.2	10.4	9.2	8.3	12	10.3	9	8.2	11.6	10.1	8.9	8.1	10	9.4	8.6	8	6.9	6.5	5.9	5.7		110
115	11.8	10.2	9	8.2	11.6	10.1	8.9	8.2	11.3	9.9	8.7	8.1	9.6	9	8.5	7.9	6.5	6.3	5.7	5.5		115
120	11.5	9.9	8.8	8.2	11.3	9.8	8.8	8.1	11	9.7	8.6	8	9.2	8.6	8.4	7.8	6.2	6	5.6	5.3		120
125	11.1	9.7	8.7	8.1	11.1	9.6	8.6	8	10.8	9.5	8.5	8	8.8	8.3	8.1	7.7	6	5.8	5.4	5.2		125
130	10.8	9.5	8.6	8.1	10.8	9.4	8.5	8	10.4	9.3	8.4	7.9	8.5	7.9	7.8	7.6	5.7	5.5	5.2	5.1		130
135	10.6	9.3	8.5	8	10.5	9.3	8.4	7.9	10	9.1	8.3	7.9	8.1	7.6	7.5	7.4	5.4	5.3	5.1	5		135
140	10.3	9.1	8.4	8	10.3	9.1	8.3	7.9	9.6	8.9	8.2	7.8	7.8	7.4	7.3	7.3	5.2	5.1	4.9	4.8		140
145	10.1	9	8.3	8	10.1	8.9	8.2	7.8	9.2	8.7	8.1	7.8	7.5	7.1	7	7.1	5	4.9	4.8	4.7		145
150	9.8	8.8	8.2	8	9.8	8.8	8.2	7.8	8.8	8.4	8	7.8	7.2	6.9	6.8	6.9	4.8	4.7	4.6	4.6		150
155	9.5	8.7	8.1	8	9.6	8.7	8.1	7.8	8.5	8.1	7.9	7.7	6.9	6.6	6.6	6.7	4.6	4.5	4.5	4.5		155
160	8.8	8.6	8.1	8	9.1	8.6	8	7.8	8.1	7.9	7.7	7.6	6.7	6.4	6.4	6.5	4.4	4.3	4.3	4.3		160
165	7.9	8.4	8	8	8.2	8.5	8	7.8	7.8	7.6	7.5	7.5	6.4	6.2	6.2	6.3	4.3	4.1	4.1	4.2		165
170	7.3	8	8	8	7.5	8.3	8	7.8	7.5	7.4	7.3	7.4	6.2	6	6	6.1	4.1	4	4	4.1		170
175	6.7	7.3	7.7	7.8	7	7.7	7.9	7.8	6.9	7.2	7.1	7.2	6	5.9	5.9	6	4	3.8	3.8	3.9		175
180	6.2	6.7	7.1	7.3	6.4	7	7.5	7.6	6.4	6.9	7	7.1	5.8	5.7	5.7	5.8	3.8	3.7	3.7	3.8		180
185	5.7	6.2	6.5		5.9	6.5	6.9	7.1	5.9	6.5	6.8	7	5.6	5.6	5.5	5.6	3.6	3.6	3.6	3.6		185
190	5.2	5.6	5.9		5.4	5.9	6.3	6.4	5.4	6	6.4	6.7	5.4	5.4	5.4	5.6	3.4	3.4	3.4	3.5		190
195	4.8	5.1			5	5.4	5.7	5.8	5.1	5.5	5.9	6.1	5	5.3	5.3	5.4	3.2	3.3	3.3	3.4		195
200					4.6	4.9	5.2		5	5	5.4	5.5	4.6	5.1	5.2	5.4	2.9	3.2	3.2	3.3		200
205					4.5	4.6			4.8	4.9	4.9	5.1	4.2	4.8	5	5.2	2.7	3	3.1	3.2		205
210									4.7	4.7	4.8		3.9	4.3	4.7	4.8	2.4	2.8	3	3.1		210
215									4.6	4.6	4.7		3.5	3.9	4.2	4.3	2.2	2.6	2.8	2.8		215
220									4.3	4.5			3.1	3.5	3.8	3.8		2.4	2.6	2.6		220
225													2.8	3.2	3.4	3.3						225
230														2.8								230
235														2.4								235
I			92				92				92/46				92				100		I	
II			92				92				92/92				92				100		II	
III			92				92				92/92				92				100		III	
IV			46				46				92/92				92				100		IV	
V			0				46				46/92				92				100		V	

* bi-parted folding jib / fléchette pliante à 2 éléments

TAB 103326 / 103328 / 103330 / 103332



Lifting capacities on the folding jib. Forces de levage à la fléchette pliante.

LTM 1160/2



142 ft – 197 ft

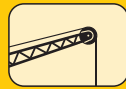

0°/15°/30°/45°
95 ft*



360°

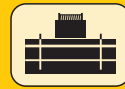

110230 lbs

85%

ft	142 ft				156 ft				171 ft				185 ft				197 ft				ft
	95 ft				95 ft				95 ft				95 ft				95 ft				
	0°	15°	30°	45°	0°	15°	30°	45°	0°	15°	30°	45°	0°	15°	30°	45°	0°	15°	30°	45°	
40	12.6				11.6				10.7												40
45	12.6				11.6				10.7												45
50	12.5				11.6				10.7				9.7				7.6				50
55	12.3				11.6				10.6				9.6				7.4				55
60	12.1	10.7			11.4	9.9			10.4				9.4				7.2				60
65	11.9	10.7			11.2	9.9			10.2				9.2				7.1				65
70	11.7	10.5			11	9.8			10	9.1			9.1	8.3			6.9	6.4			70
75	11.5	10.3			10.8	9.6			9.8	8.9			8.9	8.2			6.7	6.2			75
80	11.3	10	7.7		10.5	9.4	7.4		9.7	8.7			8.7	8			6.5	6			80
85	11	9.7	7.4		10.3	9.2	7.2		9.5	8.5			8.6	7.9			6.3	5.7			85
90	10.7	9.4	7.2		10	9	7		9.3	8.3	6.8		8.4	7.8	6.5		6.1	5.5	4.8		90
95	10.4	9	6	6.1	9.8	8.8	6.8		9.1	8.1	6.6		8.3	7.7	6.3		5.9	5.3	4.7		95
100	10.1	8.7	6.8	6	9.5	8.5	6.6	5.8	8.9	7.9	6.4	5.8	8.1	7.5	6.2		5.7	5.1	4.5		100
105	9.8	8.3	6.6	5.9	9.3	8.2	6.5	5.8	8.7	7.8	6.3	5.7	8	7.3	6	5.3	5.5	4.9	4.3	3.9	105
110	9.5	8	6.4	5.8	9.1	7.9	6.3	5.7	8.5	7.6	6.1	5.6	7.7	7.1	5.9	5.3	5.3	4.7	4.2	3.9	110
115	9.3	7.7	6.3	5.7	8.9	7.6	6.2	5.6	8.3	7.4	6	5.5	7.4	6.9	5.8	5.3	5.1	4.5	4	3.8	115
120	9	7.4	6.1	5.5	8.7	7.4	6	5.5	8.2	7.2	5.9	5.4	7.1	6.7	5.7	5.2	4.8	4.3	3.9	3.6	120
125	8.7	7.2	5.9	5.4	8.5	7.1	5.9	5.4	8	7	5.8	5.3	6.8	6.5	5.6	5.1	4.6	4.1	3.7	3.5	125
130	8.4	6.9	5.8	5.4	8.3	6.9	5.7	5.3	7.8	6.8	5.6	5.2	6.5	6.3	5.4	5.1	4.4	3.9	3.6	3.4	130
135	8	6.7	5.7	5.3	8	6.7	5.6	5.2	7.7	6.6	5.5	5.1	6.3	6.1	5.3	5	4.2	3.8	3.5	3.3	135
140	7.7	6.5	5.5	5.2	7.8	6.5	5.5	5.1	7.5	6.5	5.4	5	6	5.8	5.3	5	4	3.6	3.3	3.2	140
145	7.4	6.4	5.4	5.1	7.5	6.3	5.4	5.1	7.3	6.3	5.3	4.9	5.8	5.6	5.2	4.9	3.8	3.5	3.2	3.1	145
150	7.2	6.2	5.3	5	7.2	6.2	5.3	5	7	6.1	5.2	4.9	5.6	5.4	5.1	4.8	3.6	3.4	3.1	3	150
155	6.9	6	5.2	5	7	6	5.2	4.9	6.8	6	5.1	4.9	5.4	5.2	5	4.8	3.4	3.2	3	2.9	155
160	6.7	5.9	5.1	4.9	6.8	5.9	5.1	4.9	6.5	5.9	5	4.8	5.2	5	4.9	4.7	3.2	3.1	2.9	2.8	160
165	6.5	5.8	5	4.9	6.5	5.8	5	4.9	6.2	5.7	5	4.8	5	4.8	4.8	4.7	3.1	3	2.8	2.7	165
170	6.3	5.7	4.9	4.9	6.3	5.7	4.9	4.9	6	5.6	4.9	4.8	4.8	4.7	4.7	4.6	2.9	2.8	2.7	2.6	170
175	6.1	5.6	4.8	4.8	6.1	5.6	4.9	4.8	5.8	5.5	4.8	4.7	4.6	4.5	4.5	4.6	2.7	2.7	2.6	2.6	175
180	5.9	5.5	4.8	4.8	6	5.5	4.8	4.8	5.6	5.4	4.8	4.7	4.5	4.4	4.4	4.5	2.6	2.6	2.5	2.5	180
185	5.7	5.4	4.8	4.8	5.8	5.4	4.7	4.8	5.4	5.3	4.7	4.7	4.3	4.2	4.2	4.3	2.4	2.4	2.4	2.4	185
190	5.3	5.3	4.8	4.8	5.4	5.3	4.7	4.8	5.2	5.1	4.6	4.7	4.2	4.1	4.1	4.2	2.3	2.3	2.3	2.4	190
195	4.9	5.2	4.8	4.8	5	5.2	4.7	4.8	4.8	5	4.6	4.7	4	3.9	4	4	2.2	2.2	2.2	2.3	195
200	4.5	5	4.8	4.8	4.6	5.1	4.7	4.8	4.5	4.9	4.6	4.7	3.9	3.8	3.8	3.9				2.2	200
205	4.1	4.6	4.7		4.2	4.8	4.7	4.8	4	4.7	4.6	4.7	3.8	3.7	3.7	3.8					205
210	3.7	4.2	4.5		3.8	4.4	4.7	4.8	3.7	4.4	4.6	4.7	3.6	3.6	3.6	3.7					210
215	3.3	3.7	4		3.4	4	4.3	4.4	3.4	3.9	4.4	4.6	3.4	3.5	3.5	3.6					215
220					3.1	3.6	3.9		3.3	3.6	4	4.2	3	3.4	3.4	3.6					220
225					2.9	3.2	3.4		3.1	3.2	3.5	3.7	2.7	3.2	3.3	3.5					225
230									3	3.1	3.1			2.9	3.2	3.4					230
235									2.9	3	3			2.6	3	3.1					235
240									2.8	2.9	3				2.6	2.7					240
I			92			92				92/46				92				100			I
II			92			92				92/92				92				100			II
III			92			92				92/92				92				100			III
IV			46			46				92/92				92				100			IV
%			0			46				46/92				92				100			V

* three-parted folding jib / fléchette pliante à 3 éléments

TAB 103326 / 103328 / 103330 / 103332



Lifting capacities on the folding jib. Forces de levage à la fléchette pliante.

LTM 1160/2

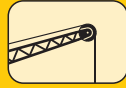

142 ft – 197 ft

0°/15°/30°/45°
118 ft*

360°



110230 lbs

85%

ft	142 ft				156 ft				171 ft				185 ft				197 ft	ft
	118 ft				118 ft				118 ft				118 ft				118 ft	
	0°	15°	30°	45°	0°	15°	30°	45°	0°	15°	30°	45°	0°	15°	30°	45°	0°	
40	8.2																	40
45	8.1																	45
50	8				7.8				7.3									50
55	8				7.7				7.3				6.5					55
60	7.9				7.6				7.3				6.5				5.3	60
65	7.8				7.5				7.1				6.4				5.2	65
70	7.7	7.2			7.4				7.1				6.3				5	70
75	7.6	7			7.4	6.7			7	6.2			6.2	5.6			4.9	75
80	7.5	6.8			7.3	6.5			6.8	6.1			6.1	5.5			4.7	80
85	7.4	6.7			7.2	6.3			6.7	6			6	5.4			4.6	85
90	7.3	6.5			7	6.2			6.5	5.9			5.9	5.4			4.4	90
95	7.2	6.2	4.8		6.8	6			6.4	5.7			5.8	5.3			4.2	95
100	7.1	6.1	4.7		6.7	5.8	4.5		6.2	5.6	4.3		5.7	5.2	4.1		4.1	100
105	6.9	5.9	4.5		6.5	5.6	4.4		6.1	5.4	4.2		5.6	5.1	4		3.9	105
110	6.7	5.7	4.4		6.4	5.5	4.2		6	5.3	4.1		5.4	4.9	3.9		3.7	110
115	6.5	5.5	4.2	3.6	6.2	5.3	4.1		5.8	5.1	4		5.3	4.8	3.7		3.6	115
120	6.3	5.3	4.1	3.6	6.1	5.2	3.9	3.4	5.7	5	3.8	3.4	5.2	4.7	3.7	3.2	3.4	120
125	6.1	5.1	3.9	3.5	5.9	5	3.9	3.4	5.6	4.8	3.7	3.3	5.1	4.6	3.6	3.2	3.2	125
130	5.9	4.9	3.8	3.4	5.8	4.8	3.7	3.3	5.4	4.7	3.6	3.2	5	4.4	3.5	3.1	3	130
135	5.7	4.7	3.7	3.3	5.6	4.6	3.6	3.2	5.3	4.5	3.5	3.2	4.8	4.3	3.4	3	2.9	135
140	5.4	4.6	3.6	3.3	5.4	4.5	3.5	3.2	5.2	4.4	3.4	3.1	4.6	4.2	3.3	3		140
145	5.2	4.4	3.5	3.2	5.2	4.3	3.4	3.1	5.1	4.3	3.4	3.1	4.4	4.1	3.2	3		145
150	5	4.2	3.4	3.1	5	4.2	3.3	3.1	4.9	4.1	3.3	3	4.2	4	3.1	2.9		150
155	4.9	4.1	3.3	3	4.9	4.1	3.3	3	4.8	4	3.2	2.9	4	3.9	3.1	2.9		155
160	4.7	4	3.2	3	4.7	4	3.2	2.9	4.6	3.9	3.1	2.9	3.9	3.8	3	2.8		160
165	4.5	3.8	3.1	2.9	4.5	3.8	3.1	2.9	4.5	3.8	3	2.8	3.7	3.7	2.9	2.8		165
170	4.4	3.7	3.1	2.9	4.4	3.7	3.1	2.8	4.3	3.7	3	2.8	3.6	3.5	2.9	2.7		170
175	4.2	3.6	3	2.8	4.2	3.6	3	2.8	4.2	3.6	2.9	2.7	3.4	3.4	2.8	2.7		175
180	4.1	3.5	2.9	2.8	4.1	3.5	2.9	2.8	4.1	3.5	2.9	2.7	3.3	3.2	2.7	2.7		180
185	3.9	3.4	2.9	2.8	4	3.4	2.9	2.7	3.9	3.4	2.8	2.7	3.1	3.1	2.7	2.6		185
190	3.8	3.3	2.8	2.7	3.9	3.4	2.8	2.7	3.8	3.3	2.7	2.7	3	2.9	2.7	2.6		190
195	3.7	3.3	2.7	2.7	3.8	3.3	2.7	2.7	3.7	3.3	2.7	2.7	2.9	2.8	2.6	2.6		195
200	3.6	3.2	2.7	2.7	3.6	3.2	2.7	2.7	3.6	3.2	2.7	2.7	2.8	2.7	2.6	2.6		200
205	3.5	3.1	2.7	2.7	3.5	3.1	2.7	2.7	3.5	3.1	2.6	2.6	2.6	2.6	2.6	2.6		205
210	3.4	3.1	2.7	2.7	3.4	3.1	2.7	2.7	3.4	3.1	2.5	2.6	2.5	2.5	2.5	2.5		210
215	3.2	3	2.7	2.7	3.3	3	2.7	2.7	3.2	3	2.5	2.6	2.4	2.4	2.4	2.5		215
220	3	2.9	2.7	2.7	3	3	2.7	2.7	2.8	3	2.5	2.6	2.3	2.3	2.3	2.4		220
225	2.6	2.9	2.7		2.7	2.9	2.7	2.7	2.5	2.9	2.5	2.6	2.2		2.2	2.3		225
230		2.8	2.7			2.9	2.7	2.7		2.9	2.5	2.6				2.2		230
235		2.5	2.7			2.6	2.7	2.7		2.6	2.5	2.6				2.2		235
240						2.3	2.5				2.5	2.6						240
245												2.5						245
I		92				92				92/46				92			100	I
II		92				92				92/92				92			100	II
III		92				92				92/92				92			100	III
IV		46				46				92/92				92			100	IV
% V		0				46				46/92				92			100	V

* four-parted folding jib / fléchette pliante à 4 éléments

TAB 103326 / 103328 / 103330 / 103332



Lifting heights. Hauteurs de levage.

LTM 1160/2

Folding jib.
Fléchette pliante.

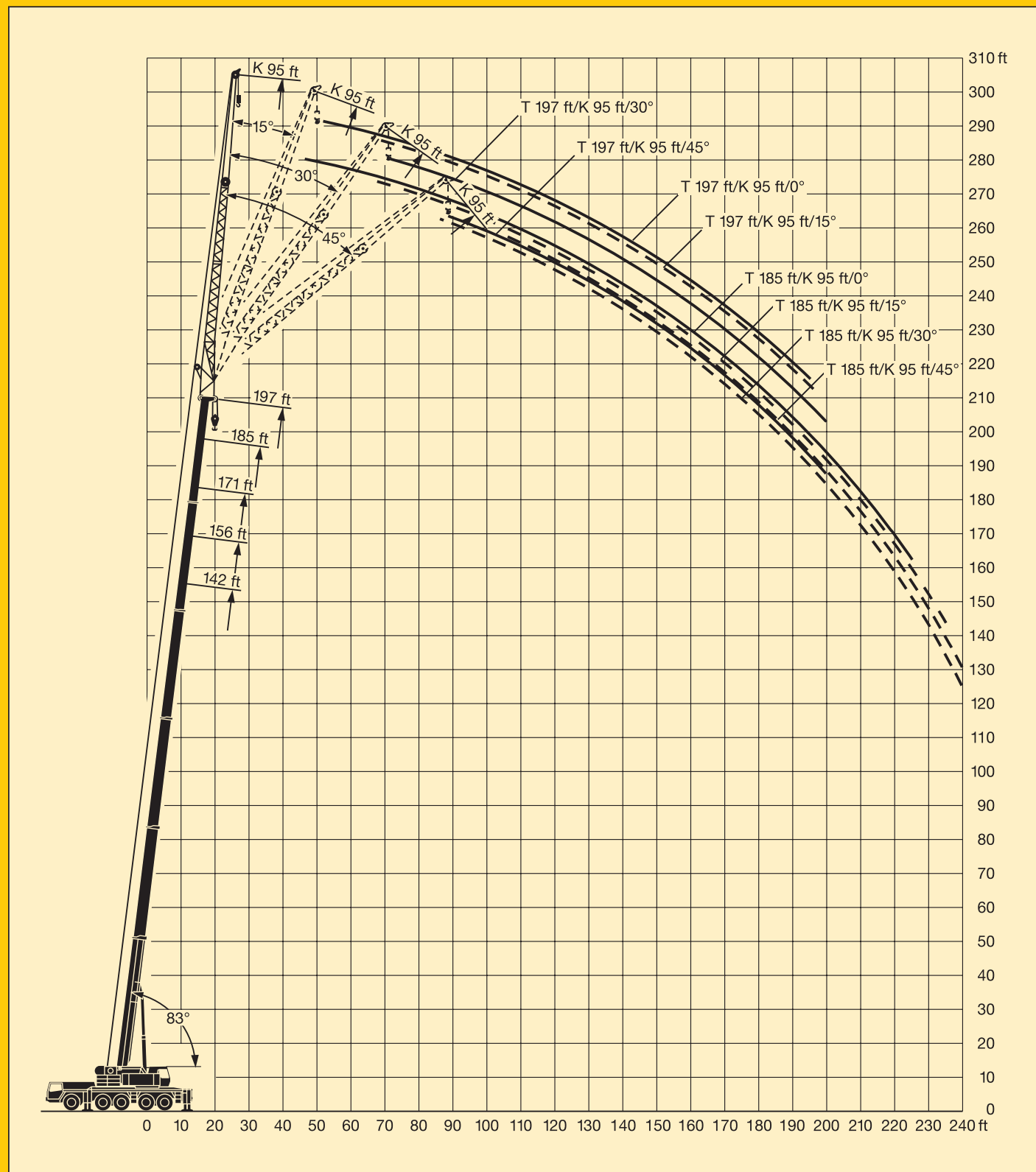



Lifting heights. Hauteurs de levage.

LTM 1160/2

Folding jib.
Fléchette pliante.

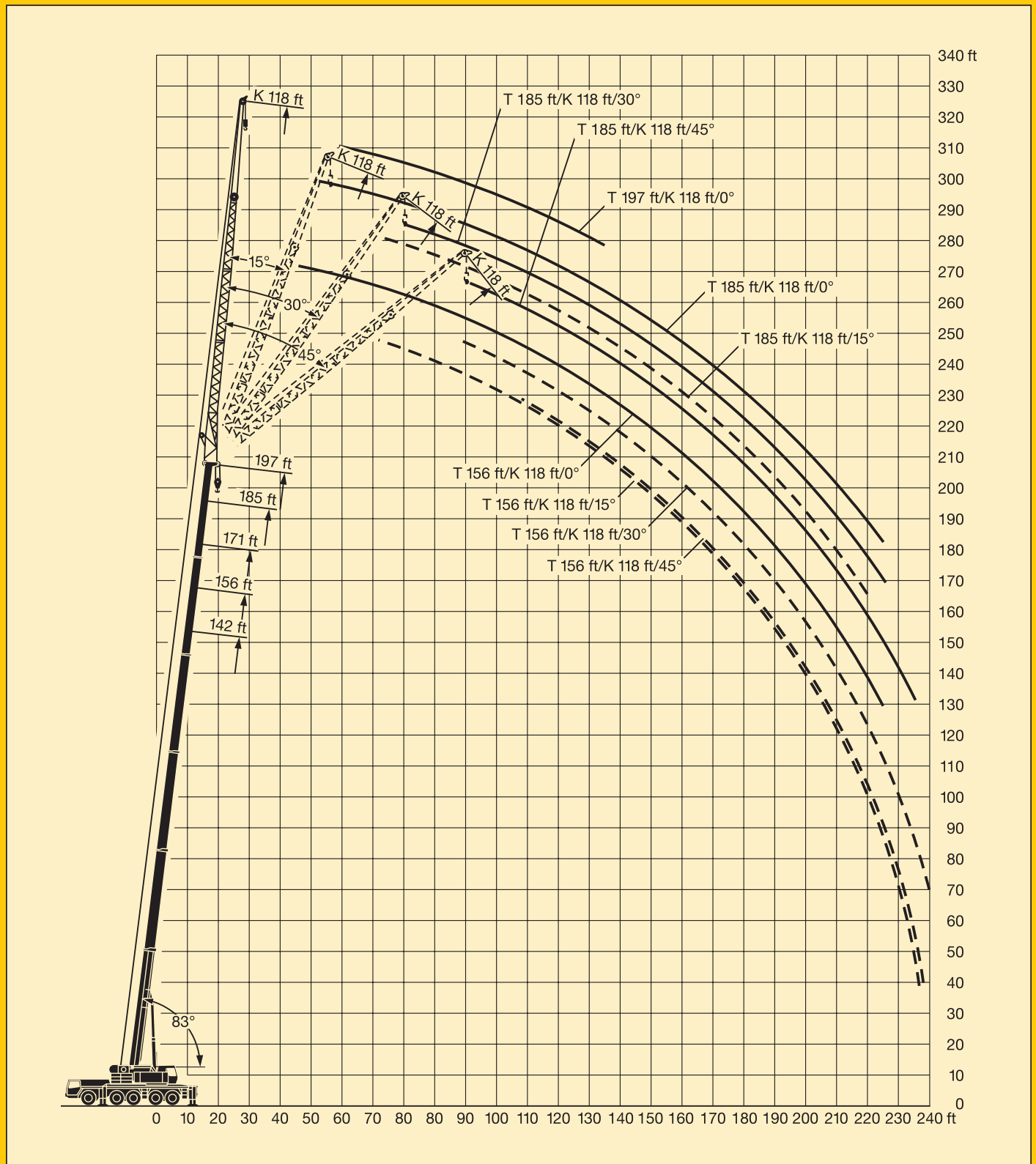



Dimensions. Encombrement.

LTM 1160/2

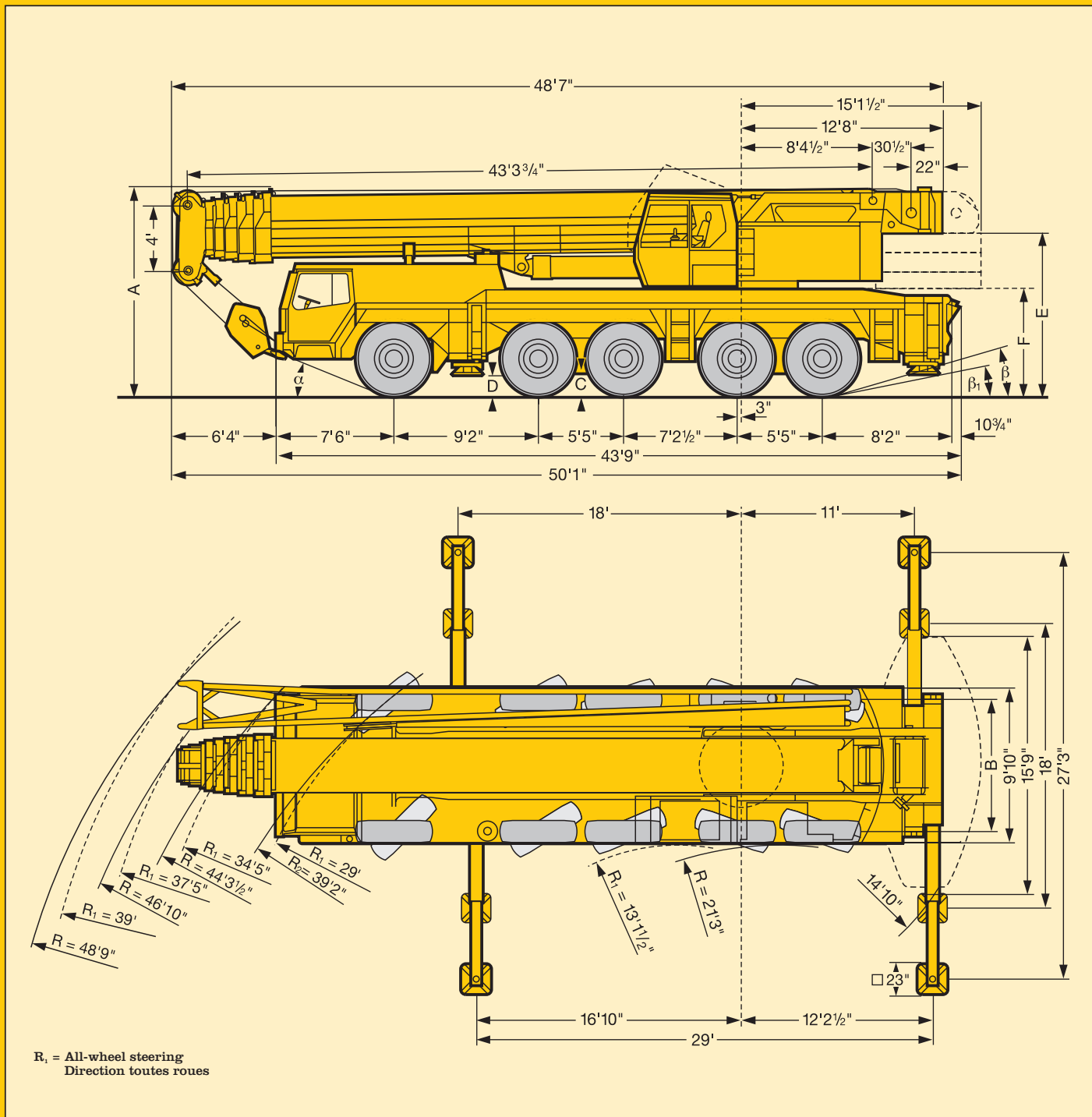

	Dimensions / Encombrement									
	A	A	B	C	D	E	F	α	β	β ₁
16.00 R 25	13'2"	12'7 1/2"	8'5"	18'1/2"	14'3/4"	10'1"	6'11 1/2"	23°	16°	11°

* lowered / abaissé



Weights. Poids.

LTM 1160/2



Axle Essieu	1	2	3	4	5	Total weight Poids total
lbs	26500	26500	26500	26500	26500	132500



Load (kips) Forces de levage (kips)	No. of sheaves Poulies	No. of lines Brins	Weight lbs Poids lbs
176	9	18	5290
150	7	14	3240
110	5	11	2760
75	3	7	1985
33	1	3	1675
11	-	1	860

Working speeds. Vitesses.



	1	2	3	4	5	R	
	9.3	14.3	22.3	33	47	8	-
	5	8	13	19.3	27.3	4.7	45 %
	16.00 R 25						



Drive Mécanismes	infinitely variable en continu	Rope diameter / Rope length Diamètre du câble / Longueur du câble	Max. single line pull Effort au brin maxi.
	0 - 460 ft/min single line ft/min au brin simple	¹¹ / ₁₂ " / 970'	22800 lbs
	0 - 460 ft/min single line ft/min au brin simple	¹¹ / ₁₂ " / 970'	22800 lbs
	0 - 1.5 rpm		
	approx. 50 seconds to reach 83° boom angle env. 50 s jusqu'à 83°		
	approx. 400 seconds for boom extension from 43 ft - 197 ft env. 400 s pour passer de 43 ft - 197 ft		



Crane carrier.

LTM 1160/2

Frame:	Liebherr designed and manufactured, box type, torsion resistant, all-welded construction made of high-tensile structural steel.
Outriggers:	4 sliding beams with hydraulic extension cylinders and hydraulic support pad jacks. Front outriggers mounted between axles 1 and 2, rear outriggers at rear of truck chassis.
Engine:	Diesel, 8 cylinder, watercooled, make Liebherr, type D 9408 TI-E, output 400 kW DIN (544 HP) at 2100 rpm, acc. to ECE-R 24.03 and ECE-R 49.02 (EURO II), max. torque 1640 lbs-ft at 1575 rpm. Fuel tank capacity: 92 gallons.
Transmission:	Allison, type CLBT 755, automatic transmission with torque converter and hydro-dynamic retarder brake. 5 forward speeds, 1 reverse. Transfer case with differential, off-road range and additional activation of front wheel drive.
Axles:	Heavy duty crane truck axles, all 5 axles sprung. All axles steered. Axles 1, 4 and 5 are planetary axles, intermediate differential at axle 4, all driven axles with transverse differential.
Cardan shafts:	All cardan shafts with 70° diagonal toothing.
Suspension:	All axles with hydropneumatic suspension and automatic levelling. Load equalization between axle pairs 1 + 2 and 4 + 5. Axles can be locked hydraulically.
Tyres:	10 tyres, all axles with single tyres. Tyre size: 16.00 R 25.
Steering:	ZF semi-integral power steering, dual circuit system, with hydraulic servo system and auxiliary pump circuit.
Brakes:	Service brake: Servo-air brakes acting on all wheels, dual circuit system. Hand brake: Spring loaded, acting on all wheels of axles 2 to 5.
Operator's cab:	Large-area, galvanized all-steel cab with resilient mountings, safety glass windows and full range of instruments.
Electrical system:	24 V DC, 2 batteries, lighting according to countries' regulations.

Crane superstructure.

Frame:	Liebherr-made torsion resistant, welded construction of high-tensile steel. Linked to crane carrier by a triple roller slewing ring for 360° continuous rotation.
Crane engine:	Diesel, 4 cylinder, watercooled, make Liebherr, type D 924 TI-E, output 149 kW DIN (203 HP) at 1800 rpm, acc. to ISO 8178 C 1 acc. to California Smoke Cycle, max. torque 656 lbs-ft at 1400 rpm. Fuel tank capacity: 79 gallons.
Crane drive:	Diesel-hydraulic, with 2 axial piston swivelling pumps with servo control and automatic output regulation.
Crane control:	By 2 self-centering control levers (joy-sticks).
Hoist gear:	Axial piston variable displacement motor, hoist drum with integrated planetary gear and spring loaded static brake.
Luffing gear:	Differential hydraulic ram with nonreturn valves.
Slewing gear:	Axial piston fixed displacement motor, planetary gear, slewing pinion and spring loaded static brake.
Crane cab:	All-steel construction, equipped conveniently, controls and instruments, ergonomically arranged. Cab tiltable backwards.
Safety devices:	LICCON safe load indicator, hoist limit switch, safety valves against rupture of pipes and hoses.
Telescopic boom:	1 base section and 5 telescopic sections. Individual hydraulic extension of all sections. Boom length: 43 ft – 197 ft.
Electrical system:	24 V DC, 2 batteries.

Complementary equipment.

Folding jib:	Double folding jib 40 ft – 118 ft long for mounting on telescopic boom at 0°, 15°, 30° and 45°.
2nd hoist gear:	For 2-hook operation.
Drive 10 x 8:	Axle 2 additionally driven.

Further equipment available on request.



Châssis porteur.

LTM 1160/2

Châssis:	De fabrication Liebherr, construction en caisson indéformable en acier allié.
Stabilisateurs:	Quatre poutres télescopiques, avec vérins d'appui hydrauliques et semelles. Les carters des poutres de stabilisation avant sont disposés entre les essieux 1 et 2, les carters AR à l'arrière du châssis.
Moteur:	Diesel, 8 cylindres, marque Liebherr, type D 9408 TI-E, refroidissement par eau, puissance 400 kW DIN (544 ch) à 2100 rpm, selon ECE-R 24.03 et ECE-R 49.02 (Euro II), couple maxi. 1640 lbs-ft à 1575 rpm. Capacité du réservoir carburant: 92 gallons.
Boîte:	Boîte automatique, marque Allison, type CLBT 755, avec convertisseur de couple et ralentisseur hydraulique. 5 rapports AV et 1 AR. Boîte de transfert avec répartiteur différentiel, rapport tout terrain et actionnement additionnel de l'entraînement de l'essieu avant.
Essieux:	Essieux spéciaux lourds. Tous les 5 essieux disposent d'une suspension intégrale. Tous les essieux sont directeurs. Les essieux 1, 4 et 5 sont des essieux planétaires, différentiel intermédiaire à l'essieu 4, tous les essieux moteurs avec différentiel transversal.
Arbres articulés:	Tous les arbres articulés à denture étagée de 70°.
Suspension:	Tous les essieux à suspension hydropneumatique avec système d'équilibrage automatique. Egalisation de la charge par essieu entre essieux 1 + 2 et 4 + 5. Suspension blocable hydrauliquement.
Pneumatiques:	10 pneumatiques, tous les essieux munis de roues simples. Dimension des pneumatiques: 16.00 R 25.
Direction:	Direction hydraulique semi-bloc ZF, à deux circuits, assistée hydrauliquement, avec pompe auxiliaire entraînée par essieu.
Freins:	Assistés pneumatiquement, agissant sur toutes les roues, conformes au code. Frein à main: par cylindres à ressort agissant sur les essieux 2 à 5.
Cabine:	Cabine spacieuse entièrement réalisée en tôles d'acier galvanisée, suspension assurée par silent-blocs, vitrage de sécurité, tableau de bord complet.
Installation électrique:	24 volts continus, 2 batteries, éclairage conforme au code.

Partie tournante.

Châssis:	De fabrication Liebherr, soudé, en acier spécial, résistant à la torsion. Couronne d'orientation à triple rangée de rouleaux, orientation sur 360°.
Moteur:	Diesel, 4 cylindres, marque Liebherr, type D 924 TI-E, refroidissement par eau, puissance 149 kW DIN (203 ch) à 1800 rpm, selon ISO 8178 C 1, selon California Smoke Cycle, couple maxi. 656 lbs-ft à 1400 rpm. Capacité du réservoir carburant: 76 gallons.
Entraînement:	Diesel-hydraulique comprenant 2 pompes à débit variable à servo-commande et régulation de puissance.
Commande:	Deux manipulateurs (type manche à balai).
Mécan. de levage:	Moteur hydraulique à cylindrée variable, treuil à réducteur planétaire incorporé et frein d'arrêt à ressort.
Mécan. de relevage:	Vérin différentiel, avec clapets anti-retour de sécurité.
Mécan. d'orientation:	Moteur hydraulique à cylindrée constante, réducteur planétaire, frein d'arrêt à ressort.
Cabine:	Entièrement réalisée en tôles d'acier avec équipement confortable, organes de commande et appareils de contrôle, arrangés ergonomiquement. Cabine inclinable vers l'arrière.
Dispositifs de sécurité:	Contrôleur de charge LICCON, fin de course de levage, soupapes de sûreté sur tubes et flexibles contre rupture.
Flèche télescopique:	Flèche à télescopage hydraulique formée d'un élément de base et de 5 éléments télescopables. Télescopage individuel de tous les éléments. Longueur de flèche: 43 ft - 197 ft.
Installation électrique:	24 volts continus, 2 batteries.

Équipement optionnel.

Fléchette pliante:	Fléchette pliante double, 40 ft - 118 ft, pour montage à la flèche télescopique à 0°, 15°, 30° et 45°.
2ème mécan. de levage:	Pour le travail avec 2 crochets.
Entraînement 10 x 8:	2ème essieu est entraîné additionnellement.
Autres équipements supplémentaires sur demande.	



View thousands of Crane Specifications on FreeCraneSpecs.com



View thousands of Crane Specifications on FreeCraneSpecs.com

Subject to modification. / Sous réserve de modifications.

TP 225 f. CA. 2.98

Please contact

Veillez prendre contact avec

LIEBHERR-WERK EHINGEN GMBH

D-89582 Ehingen/Donau, Telefon (0 73 91) 5 02-0, Telefax (0 73 91) 5 02-3 99

www.lwe.liebherr.de, E-mail: info@lwe.liebherr.com

CD-